



PR005S / PR015S

for Heat-Resistant Alloy



Stable and Consistent Performance While Machining Heat-Resistant Alloy

Improved Thermal Properties Help to Reduce Sudden Fracture and Decrease Edge Wear

Improved Wear Resistance with MEGACOAT HARD Coating

Low Cutting Force and Stable Machining with Newly Developed Chipbreakers (SQ/SX/SG)





PR005S / PR015S

for Machining Heat-Resistant Alloy

Improved Thermal Properties Help to Reduce Sudden Fracture and Edge Wear

1 Newly Developed Substrate Helps to Reduce Sudden Fracture and Notch Wear

Improved thermal conductivity by optimum distribution of WC coarse grains

Resists heat concentration at the cutting edge to promote stable machining

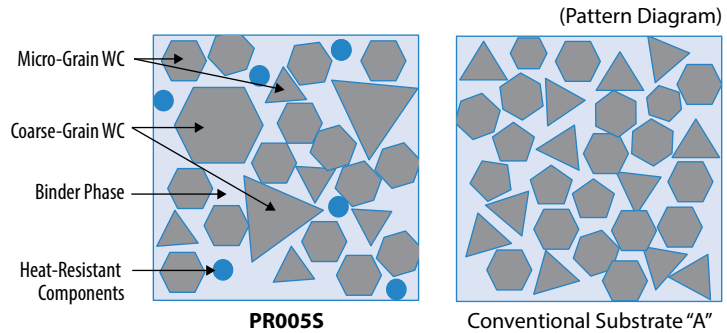

PR005S : Hard, Wear-resistant Grade for High-speed Machining

PR015S : General Purpose Grade with Excellent Wear Resistance and Stability

Fracture Resistance Comparison (Internal Evaluation)

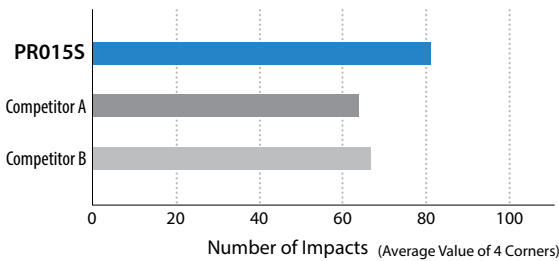

Cutting Conditions: $V_c = 80$ sfm, $D.O.C. = 0.039"$, $f = 0.004$ ipr, Wet
CNMG432 Type Workpiece: Nickel-based Superalloy Cylindrical Workpiece with 1 Flat Face

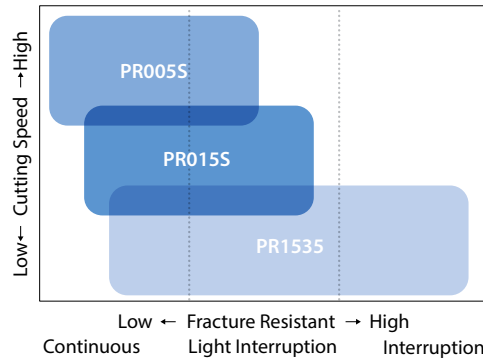

2 Improved Wear Resistance with MEGACOAT HARD Coating

Coating Film Property (Internal Evaluation)

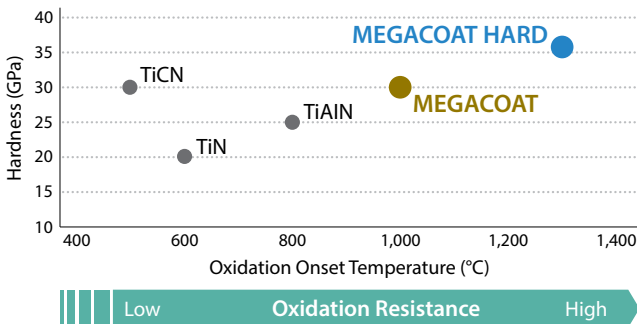

Excellent wear resistance with high-hardness resists boundary damage with improved thermal properties

Wear Resistance Comparison (Internal Evaluation)

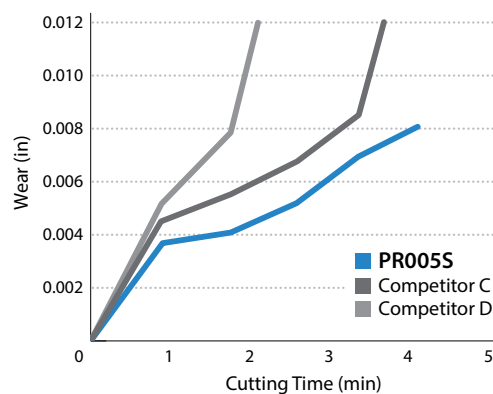

Machining Time: 3.5 min
Competitor D could only reach 2.6 minutes.

PR005S



Competitor C



Competitor D



Cutting Conditions: $V_c = 200$ sfm, $D.O.C. = 0.039"$, $f = 0.008$ ipr, Wet, CNMG432 Type
Workpiece: Nickel-based Superalloy

3 New Chipbreaker Designs Improve Machining Stability

SQ Chipbreaker for Finishing to Medium Machining

Double-sided 4-Corner Design

Extended Tool Life and Improved Efficiency for Medium-Finishing Applications in Heat-Resistant Alloys

SQ Chipbreaker Benefits
 Reduced Temperature at the Cutting Edge for Extended Tool Life
 Reduces Burring for Extended Tool Life and Efficiency Improvements



Slant Cutting Edge
 Inclined in (-) Direction
 Effective for Burr Suppression and Reducing Notching

Special Axial Face Design Decreases Cutting Edge Temperature

Optimal Design Achieved with Simulation Technology

Simulation of Edge-Temperature Comparison (Internal Evaluation)

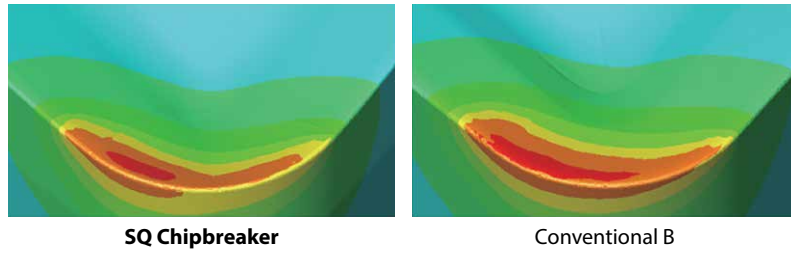

Cutting Conditions: $V_c = 130$ sfm, $D.O.C. = 0.039$ ", $f = 0.006$ ipr, CNMG432 Type, Dry
 Workpiece: Nickel-based Superalloy

The newly developed SQ chipbreaker reduces temperature at the cutting edge, thereby improving tool life and machining efficiency in semi-finishing applications.

Applicable Chipbreaker Range

(D.O.C. Indicates Radial Depth of Cut per Side)

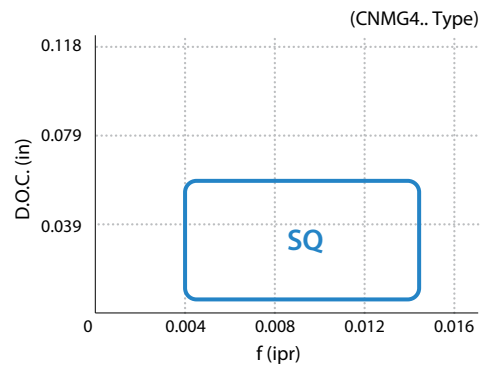

Cutting Force Comparison - Radial Force (Internal Evaluation)

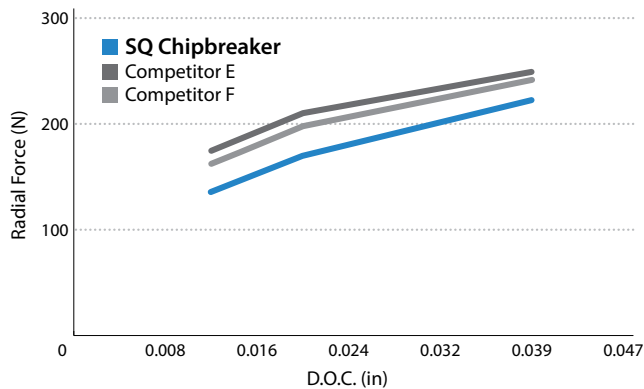

Cutting Conditions: $V_c = 130$ sfm, $f = 0.006$ ipr, Wet, CNMG432 Type
 Workpiece: Nickel-based Superalloy

Wear Resistance Comparison (Internal Evaluation)

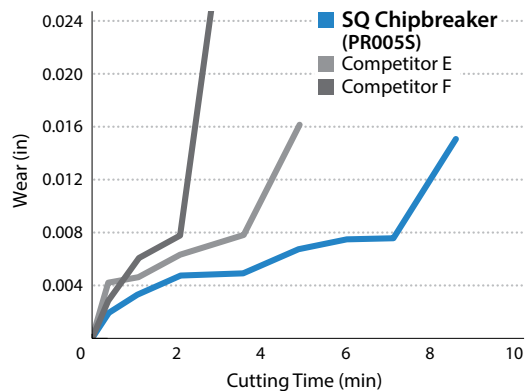

Cutting Conditions: $V_c = 130$, $D.O.C. = 0.039$ ", $f = 0.008$ ipr, Wet, CNMG432 Type
 Workpiece: Nickel-based Superalloy

Machining Time: 5 min
 Competitor F could only reach 3.6 minutes.

SQ Chipbreaker (PR0055)



Competitor E



Competitor F



SX Chipbreaker for Roughing

Single-sided 2-Corner Design

Improved Efficiency for Roughing Applications in Heat-resistant Alloys

SX Chipbreaker Benefits

- Decreased Edge Temperature for Longer Tool Life
- Suppresses Burr Formation for Greater Depths of Cut
- Decreased Radial Forces Resists Edge Build-up and Improves Efficiency

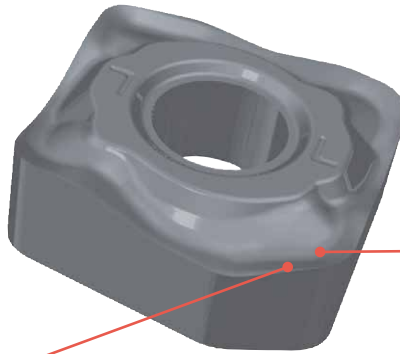

The SG chipbreaker is recommended if a double-sided 4-edge design for roughing is required

See P6 for details



Rake Design Decreases Temperature at the Cutting Edge

Optimal Design Achieved with CNC Simulation Technology

Unique Cutting Edge Design (Handed Insert)

60 Degree Lead Angle (when Installed in the Toolholder)
12 Degree Rake Angle

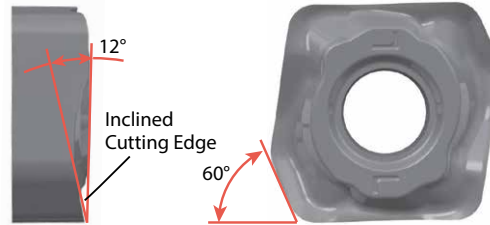

- Can be installed in standard Kyocera 80° (C type) toolholders by changing to corresponding SX shim
- Single-sided, handed insert

Simulation of Edge-Temperature Comparison (Internal Evaluation)

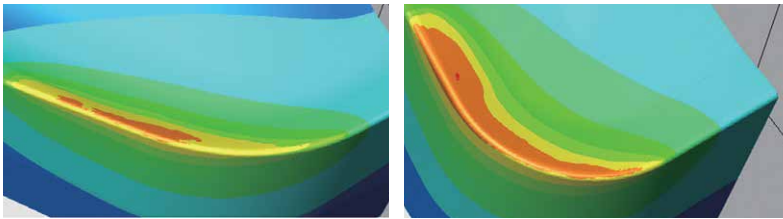

SX Chipbreaker

Conventional C

Cutting Conditions: $V_c = 130$ sfm, $D.O.C. = 0.079$ ", $f = 0.010$ ipr, Dry
CNMM43XL-SX, CNMG433 Type Workpiece: Nickel-based Superalloy

The SX Chipbreaker provides longer tool life and improved efficiency with its unique cutting edge and rake angle design

Applicable Chipbreaker Range

(D.O.C. Indicates Radial Depth of Cut per Side)

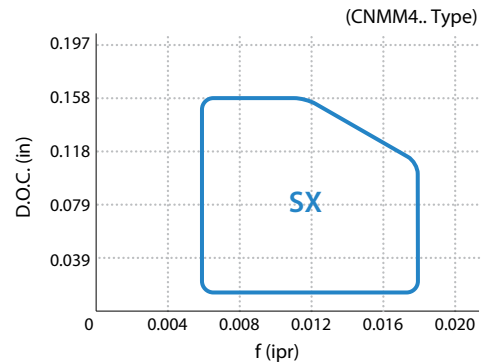

Burr Comparison (Internal Evaluation)

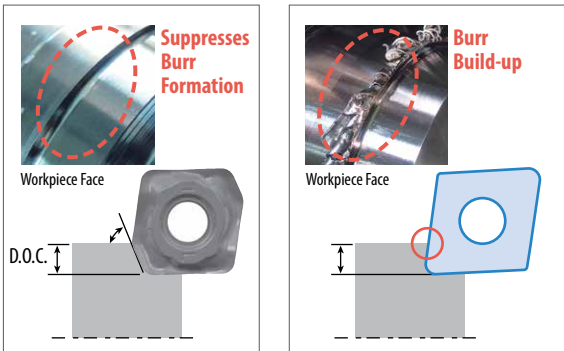

SX Chipbreaker

Conventional D

Cutting Conditions: $V_c = 130$ sfm, $D.O.C. = 0.079$ ", $f = 0.010$ ipr, Wet
CNMM43XL-SX, CNMG433 Type After Machining 9.4 min. Workpiece: Nickel-based Superalloy

Even in larger depths of cut, the SX chipbreaker is able to suppress burr build-up

Increased D.O.C capability and reduced notch wear combine to provide greater machining efficiency

Wear Resistance Comparison (Internal Evaluation)

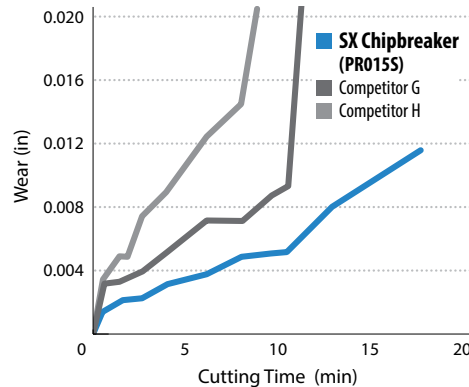

Cutting Conditions: $V_c = 130$ sfm, $D.O.C. = 0.079$ ", $f = 0.010$ ipr, Wet
CNMM43XL-SX, CNMG433 Type Workpiece: Nickel-based Superalloy

Machining Time: 5 min

SX Chipbreaker (PR0155)



Competitor G



Competitor H



SX Chipbreaker and PR0155 resist notching, thereby improving tool life

Caution when Using SX Chipbreaker

1. Cutting Edge Height

The center of the cutting edge height of the nose is slanted by 60 degrees based on circled portions in image below

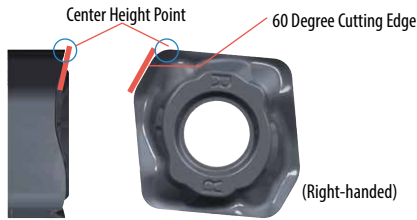

2. Recommended D.O.C.

Recommended depth of cut is no greater than the 60° lead angle; however, larger depths of cut are possible

Insert Part Number	Recommended D.O.C. External Turning (in)	Max. D.O.C. Facing (in)
CNMM43X%-SX	0.020 - 0.079 - 0.158	0.079
CNMM54X%-SX	0.020 - 0.098 - 0.177	0.079
CNMM64X%-SX	0.020 - 0.118 - 0.197	0.098

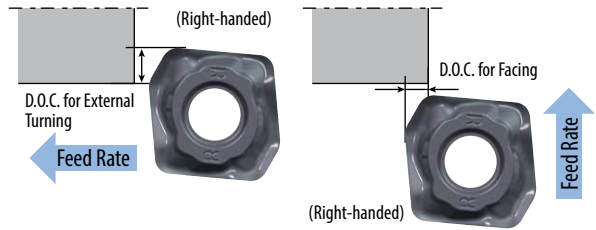

3. Applicable Toolholder

The SX chipbreaker insert requires a different shim than standard inserts
No additional toolholder modifications are necessary when using the applicable Kyocera holders

Insert Part Number	Applicable Toolholder (Kyocera)	Standard Shim	Shim for SX Chipbreaker
CNMM43X%-SX	DCLN% 12-4B DCLN% 16-4D DCLN% 2020K-12 DCLN% 2525M-12	DC-44	DC-44-C
	PCLN% 12-4B PCLN% 16-4D PCLN% 2020H-12 PCLN% 2020K-12 PCLN% 2525M-12 PCLN% 3225P-12	LC-42N	LC-42N-C
CNMM54X%-SX	PCLN% 2525M-16 PCLN% 3232P-16	LC-53N	LC-53N-C
CNMM64X%-SX	PCLN% 3232P-19	LC-63	LC-63-C

Boring is Not Recommended

4. Unmachined Portion Varies with Insert Size

Unmachined portion is reflected below

Insert Part Number	Amount Uncut (in)	
	X	Z
CNMM43X%-SX	0.161	0.114
CNMM54X%-SX	0.189	0.130
CNMM64X%-SX	0.213	0.142



5. Facing

Facing is possible, but turning is recommended
Cutting edge may drop below center in facing operations
(Boss remains at the center of the workpiece)

Insert Part Number	Run-out Amount when Facing (in)
CNMM43X%-SX	0.030
CNMM54X%-SX	0.033
CNMM64X%-SX	0.041

The SX chipbreaker is designed for high efficiency roughing. It differs from standard inserts by the following

- Handed, single-sided, 2-corner insert
- Requires a dedicated shim
- Unmachined portion remains at corner (4. Unmachined portion varies with insert size)
- Position of insert is below the center when facing (5. Facing)

SG Chipbreaker for Roughing

Double-sided 4-Corner Design

Improved Efficiency for Roughing Applications in Heat-resistant Alloys

SG Chipbreaker Benefits
 Well-balanced axial face shape for extended tool life
 Shallow bottom chipbreaker design for smooth chip control

Applicable Chipbreaker Range

(D.O.C. Indicates Radial Depth of Cut per Side)

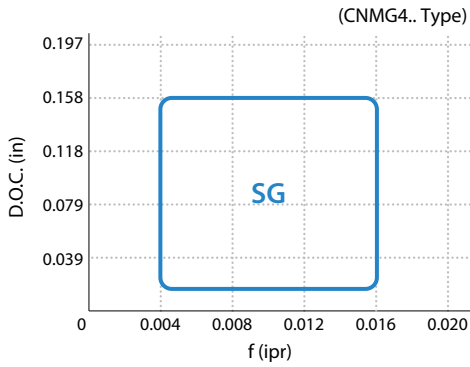

Standard Chipbreaker
 Stable chip control during heavy machining applications

Well-balanced Axial Face Shape
 High-strength land and low cutting force design



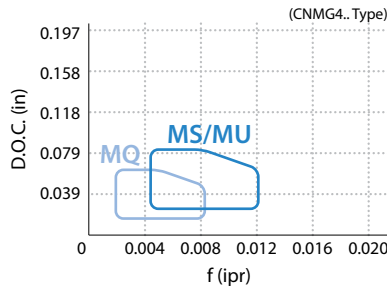
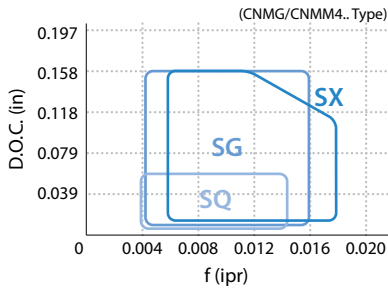







Applicable Chipbreaker Range (D.O.C. Indicates Radial Depth of Cut per Side)





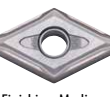













Recommended Cutting Conditions

Workpiece	Cutting Range	Application	Recommended Chipbreaker	Recommended Grade	Min. - Recommendation - Max.			
					Vc (sfm)	D.O.C. (in)	f (ipr)	
Heat-Resistant Alloys	Finishing	Continuous	MQ	PR005S	100 – 180 – 300	0.008 – 0.012 – 0.039	0.002 – 0.003 – 0.006	
		Interruption		PR015S	80 – 150 – 230	0.008 – 0.020 – 0.039	0.002 – 0.004 – 0.008	
	Medium	Continuous	MU	PR005S	100 – 180 – 300	0.020 – 0.039 – 0.079	0.004 – 0.006 – 0.012	
				PR015S	80 – 150 – 230	0.020 – 0.039 – 0.079	0.004 – 0.006 – 0.012	
		Interruption	MS	PR005S	100 – 180 – 300	0.020 – 0.039 – 0.079	0.004 – 0.006 – 0.012	
				PR015S	80 – 150 – 230	0.020 – 0.039 – 0.079	0.004 – 0.006 – 0.012	
		Continuous	SQ	PR005S	100 – 180 – 300	0.012 – 0.020 – 0.059	0.004 – 0.007 – 0.014	
				PR015S	80 – 150 – 230	0.012 – 0.020 – 0.059	0.004 – 0.007 – 0.014	
		Roughing	Continuous	SG	PR005S	100 – 180 – 300	0.020 – 0.079 – 0.158	0.004 – 0.012 – 0.016
					PR015S	80 – 150 – 230	0.020 – 0.079 – 0.158	0.004 – 0.012 – 0.016
	Interruption		SX	PR005S	100 – 180 – 300	0.020 – 0.079 – 0.158	0.006 – 0.012 – 0.018	
				PR015S	80 – 150 – 230	0.020 – 0.079 – 0.158	0.006 – 0.012 – 0.018	

Negative Inserts

		● Continuous / 1st Choice ● Light Interruption / 1st Choice		S	Heat-Resistant Alloy				● ●		
Shape	Part Number	Dimensions (in)				MEGACOAT HARD					
		IC	Thickness	Hole	Corner-R (RE)	PROSS	PRO15S				
 Finishing-Medium	CNMG 431SQ	1/2	3/16	0.203	1/64	●	●				
	432SQ				1/32	●	●				
	433SQ				3/64	●	●				
	CNMG 543SQ	5/8	1/4	0.250	3/64	●	●				
	544SQ				1/16	●	●				
CNMG 643SQ	3/4	1/4	0.313	3/64	●	●					
644SQ				1/16	●	●					
 Finishing-Medium	CNMG 431MQ	1/2	3/16	0.203	1/64	●	●				
	432MQ				1/32	●	●				
 Medium-Roughing	CNMG 431MS	1/2	3/16	0.203	1/64	●	●				
	432MS				1/32	●	●				
	433MS				3/64	●	●				
	434MS				1/16	●	●				
 Medium-Roughing	CNMG 431MU	1/2	3/16	0.203	1/64	●	●				
	432MU				1/32	●	●				
	433MU				3/64	●	●				
	CNMG 542MU	5/8	1/4	0.250	1/32	●	●				
	543MU				3/64	●	●				
	544MU				1/16	●	●				
CNMG 643MU	3/4	1/4	0.313	3/64	●	●					
644MU				1/16	●	●					
 Roughing	CNMG 432SG	1/2	3/16	0.203	1/32	●	●				
	433SG				3/64	●	●				
	CNMG 543SG	5/8	1/4	0.250	3/64	●	●				
	544SG				1/16	●	●				
CNMG 643SG	3/4	1/4	0.313	3/64	●	●					
644SG				1/16	●	●					
 Roughing	CNMM 43X ^R L-SX*	1/2	0.174	0.203	-	●	●				
	CNMM 54X ^R L-SX*	5/8	0.235	0.250	-	●	●				
	CNMM 64X ^R L-SX*	3/4	0.233	0.313	-	●	●				
 Finishing-Medium	DNMG 431SQ	1/2	3/16	0.203	1/64	●	●				
	432SQ				1/32	●	●				
	433SQ				3/64	●	●				
	DNMG 441SQ	1/2	1/4	0.203	1/64	●	●				
	442SQ				1/32	●	●				
DNMG 443SQ				3/64	●	●					
 Finishing-Medium	DNMG 431MQ	1/2	3/16	0.203	1/64	●	●				
	432MQ				1/32	●	●				
	DNMG 441MQ	1/2	1/4	0.203	1/64	●	●				
442MQ	1/32				●	●					
 Medium-Roughing	DNMG 431MS	1/2	3/16	0.203	1/64	●	●				
	432MS				1/32	●	●				
	433MS				3/64	●	●				
	DNMG 441MS	1/2	1/4	0.203	1/64	●	●				
	442MS				1/32	●	●				
DNMG 443MS				3/64	●	●					
 Medium-Roughing	DNMG 431MU	1/2	3/16	0.203	1/64	●	●				
	432MU				1/32	●	●				
	DNMG 441MU	1/2	1/4	0.203	1/64	●	●				
442MU	1/32				●	●					
 Roughing	DNMG 432SG	1/2	3/16	0.203	1/32	●	●				
	433SG				3/64	●	●				

		● Continuous / 1st Choice ● Light Interruption / 1st Choice		S	Heat-Resistant Alloy				● ●		
Shape	Part Number	Dimensions (in)				MEGACOAT HARD					
		IC	Thickness	Hole	Corner-R (RE)	PROSS	PRO15S				
 Finishing-Medium	SNMG 431MQ	1/2	3/16	0.203	1/64	●	●				
	432MQ				1/32	●	●				
 Medium-Roughing	SNMG 431MS	1/2	3/16	0.203	1/64	●	●				
	432MS				1/32	●	●				
	433MS				3/64	●	●				
	434MS				1/16	●	●				
 Medium-Roughing	SNMG 643MU	3/4	1/4	0.313	3/64	●	●				
	644MU				1/16	●	●				
 Roughing	SNMG 432SG	1/2	3/16	0.203	1/32	●	●				
	433SG				3/64	●	●				
SNMG 643SG	3/4	1/4	0.313	3/64	●	●					
644SG				1/16	●	●					
 Finishing-Medium	TNMG 331MQ	3/8	3/16	0.150	1/64	●	●				
	332MQ				1/32	●	●				
 Medium-Roughing	TNMG 331MS	3/8	3/16	0.150	1/64	●	●				
	332MS				1/32	●	●				
	333MS				3/64	●	●				
 Medium-Roughing	TNMG 331MU	3/8	3/16	0.150	1/64	●	●				
	332MU				1/32	●	●				
 Roughing	TNMG 332SG	3/8	3/16	0.150	1/32	●	●				
	333SG				3/64	●	●				
SNMG 432SG	1/2	3/16	0.203	1/32	●	●					
433SG				3/64	●	●					
 Finishing-Medium	VNMG 331MQ	3/8	3/16	0.150	1/64	●	●				
	332MQ				1/32	●	●				
 Medium-Roughing	VNMG 331MS	3/8	3/16	0.150	1/64	●	●				
	332MS				1/32	●	●				
	333MS				3/64	●	●				
 Medium-Roughing	VNMG 331MU	3/8	3/16	0.150	1/64	●	●				
	332MU				1/32	●	●				
 Roughing	VNMG 331SG	3/8	3/16	0.150	1/64	●	●				
	332SG				1/32	●	●				
 Finishing-Medium	WNMG 431MQ	1/2	3/16	0.203	1/64	●	●				
	432MQ				1/32	●	●				
 Medium-Roughing	WNMG 431MS	1/2	3/16	0.203	1/64	●	●				
	432MS				1/32	●	●				
	433MS				3/64	●	●				
 Medium-Roughing	WNMG 431MU	1/2	3/16	0.203	1/64	●	●				
	432MU				1/32	●	●				
 Roughing	WNMG 432SG	1/2	3/16	0.203	1/32	●	●				
	433SG				3/64	●	●				



*CNMM...X%L-SX inserts are single-sided with 2 cutting edges.

*CNMM...X%L-SX inserts require a different shim sold separately. See page 5 for applicable shim for SX chipbreaker inserts.

● : Standard Stock

Inserts sold in 10 piece boxes

Positive Inserts

<ul style="list-style-type: none"> ● Continuous / 1st Choice ● Light Interruption / 1st Choice 		S	Heat-Resistant Alloy				●	●
Shape	Part Number	Dimensions (in)					MEGACOAT HARD	
		IC	Thickness	Hole	Corner-R (RE)	AN	PR0055	PR0155
	CCMT 3251MQ	3/8	5/32	0.173	1/64	7°	●	●
	3252MQ				1/32		●	●
	DCMT 21505MQ	1/4	3/32	0.173	0.008	7°	●	●
	2151MQ				1/64		●	●
	DCMT 3251MQ	3/8	5/32	0.173	1/64	7°	●	●
	3252MQ				1/32		●	●

● : Standard Stock

Inserts sold in 10 piece boxes



KYOCERA Precision Tools

102 Industrial Park Road
 Hendersonville, NC 28792
 Customer Service | 800.823.7284 - Option 1
 Technical Support | 800.823.7284 - Option 2



Official Website | www.kyoceraprecisiontools.com
 Distributor Website | mykpti.kyocera.com
 Email | cuttingtools@kyocerapti.com